

Liste 1 des Circuits

<u>Coffret 1 WC</u>	
A	Lampes WC + Secour WC
B	Prévision Boiler
C	Prise Compteur
D	Coffret Mazout
E	Coffret Bureau
F	Différentiel
<u>Coffret 2 WC</u>	
A	Coffret Rez-de-Chaussée
B	Coffret 1er Etage + Coffret 2eme Etage
C	Coffret Cave
D	Réserver
E	Coffret Cuisine
<u>Coffret Cuisine</u>	
A	Lave Vaiselle
B	Ch Ass. + Sal.
C	Vapeur
D	Boite sur Porte + Lampe Escalier Cave + Lampes Cave
E	Four
F	Friteuse
G	Hotte + Ventilateur
H	Frigo
I	Prises Evier
J	Prises Frigo D.
K	Prises Frigo Tablette
L	Prises Four
M	Luste Res-de-chaussée + Lampe Cuisine + (Lampe Terrasse ANNULER)
N	Lampes Couloir WC + Lampes Hotte + Lampe Sécurité
<u>Coffret Rez-de-Chaussée</u>	
A	Lampe + Lampe Salle + Lampe Mezzanine + Lampe Sécurité
B	Lampe Sas + Lampe Verte + Ventilateur
C	Ventilateur Grill + Prises Centre
D	Prises Gauche
E	Prises Evier + Prises Mezzanine
F	Prises Café + Prises Bar
G	Pompe Jet Fontaine
H	Lampes Exterieur

Liste 2 des Circuits

<u>Coffret 1er Etage</u>	
A	Prises Avant
B	Prises Arrière
C	Prises Sono + Prises Salle
D	Lampe Sécurité + Parlophone + Lampes Chère de Vérité + Lampe Couloire
E	14 Lanternes Cuivre + 9 Spots Couleur + Lampes Sono + Lustre
F	12 V Double + 12 V Simple + Prises Chère + Lampes Sécurité + Lampes
G	Réservé
<u>Coffret 2eme Etage</u>	
A	Ventilateur Ch. + Lampes Ch. + Lampe Palier
B	Lampe Ch. Laetitia + Lampe Ch. Jenny + Lampe Escalier
C	Prises Ch. + Prises Ch. TV
D	Prises Ch. Laetitia + Lampe Sécurité + Prises Ch. Jenny
E1	Differentiel SDB
E2	Prises + Lampes 12 V SDB
E3	Prise Machine à Laver
E4	Prise Séchoir
<u>Coffret Bureau</u>	
A	Lampes Bureau + Lampes Vestiaire + Lampe WC
B	Prises Bureau + Prises Couloire
<u>Coffret Mazout</u>	
A	Lampes Cave
B	Prises Cave
C	Circulateur Chauffage
D	Circulateur Sanitaire
E	Lampe WC
<u>Coffret Cave</u>	
A	Prise Triphasée
B	Prises Congelateur + Lampe Sécurité + Petit Frigo
C	Prises Centre + Grand Frigo + Ventilateur
D	Prises Droite + Frigo Res-de-chaussée + Ventilateur
E	Alimentation 3 Minuterries

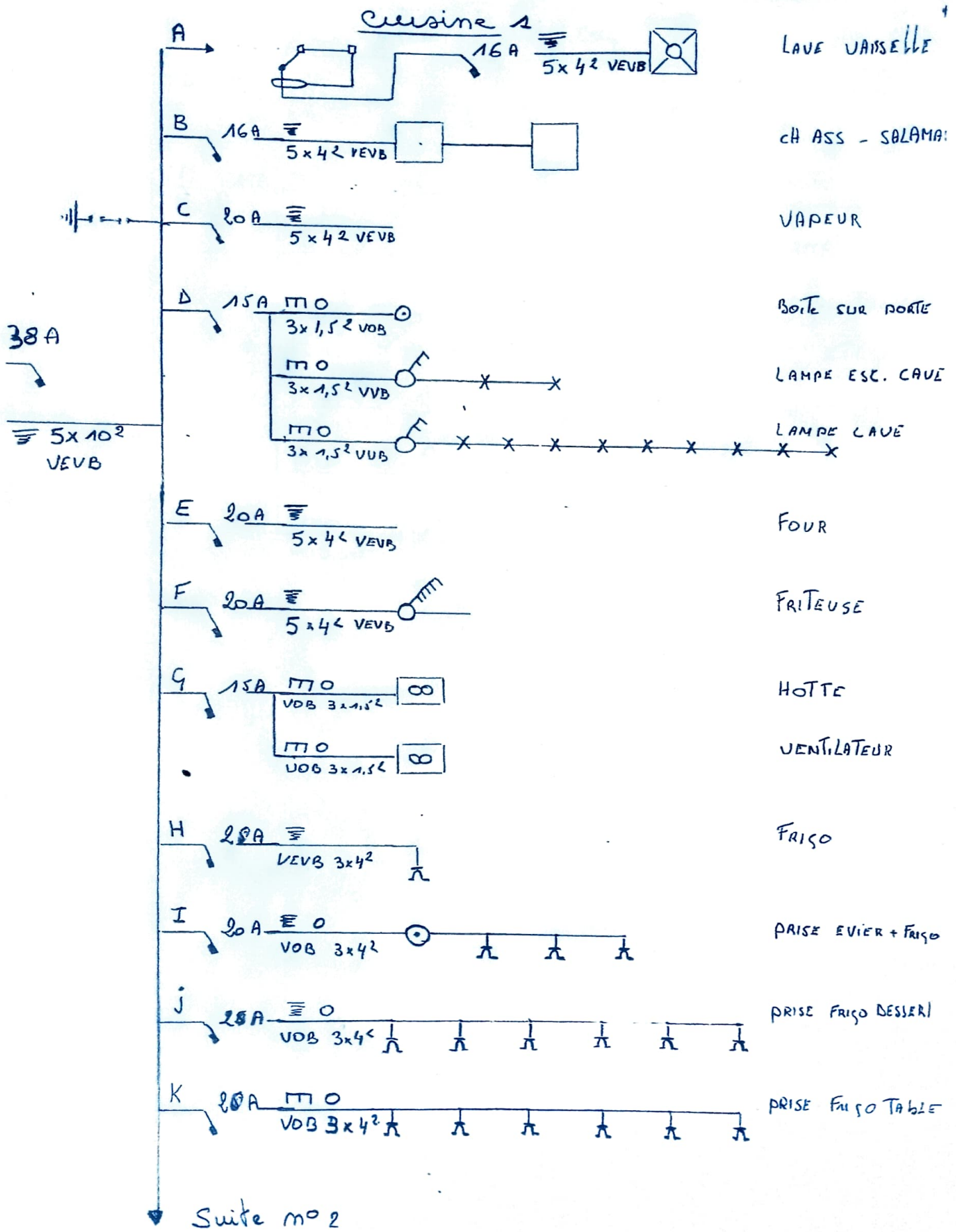

LAVE VAISSELLE

CH ASS - SALAMA

VAPEUR

BOITE SUR PORTE

LAMPE ESC. CAVE

LAMPES CAVE

FOUR

FRITEUSE

HOTTE

VENTILATEUR

FRIGO

P R I S E E V I E R + F R I G O

P R I S E F R I G O D E S S E R I

P R I S E F U S O T A B L E

38 A

5 x 10²
VEVB

Cuisine 1

16 A

16 A

20 A

15 A

20 A

20 A

15 A

20 A

20 A

20 A

20 A

Suite n° 2

cuisine 2 suite

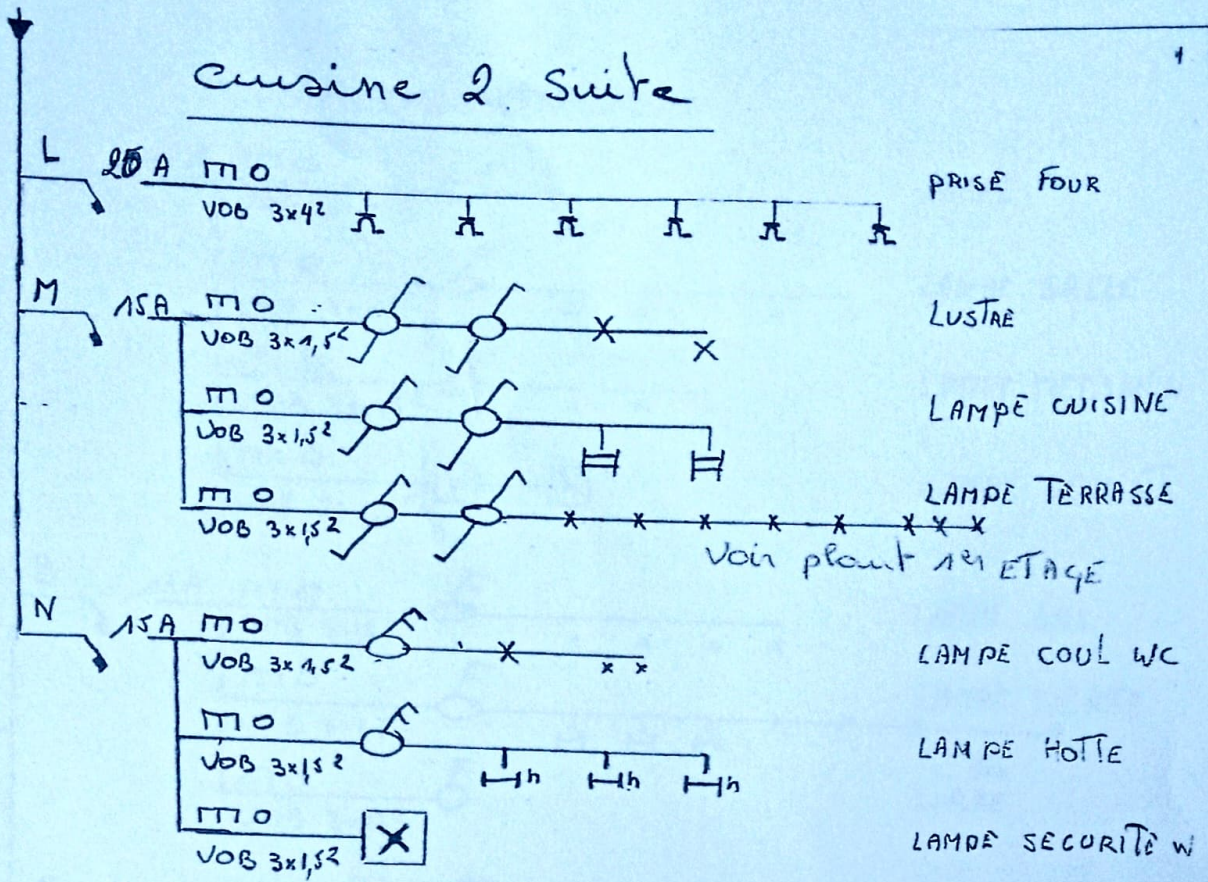

Rez-de-chaussée

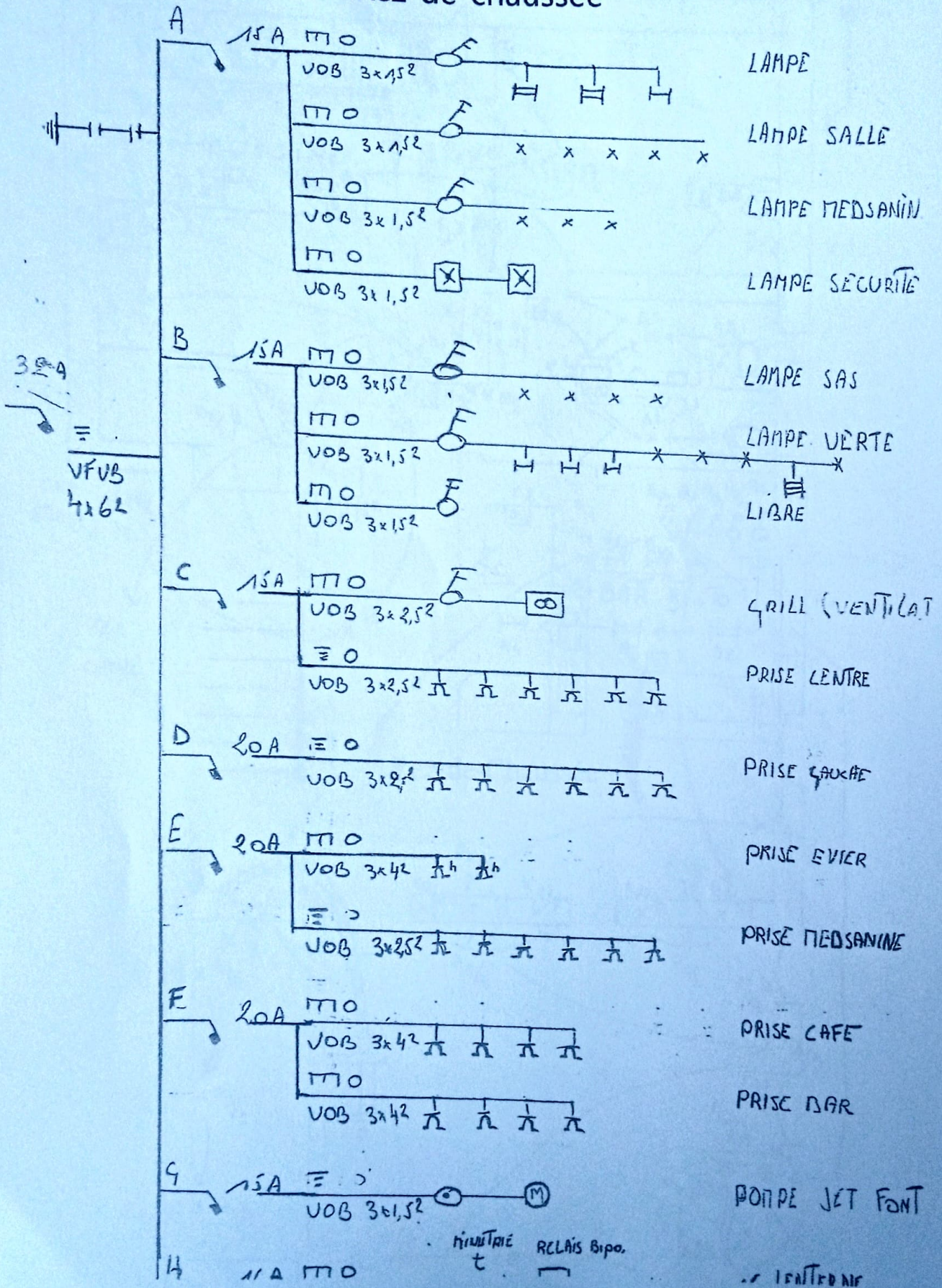

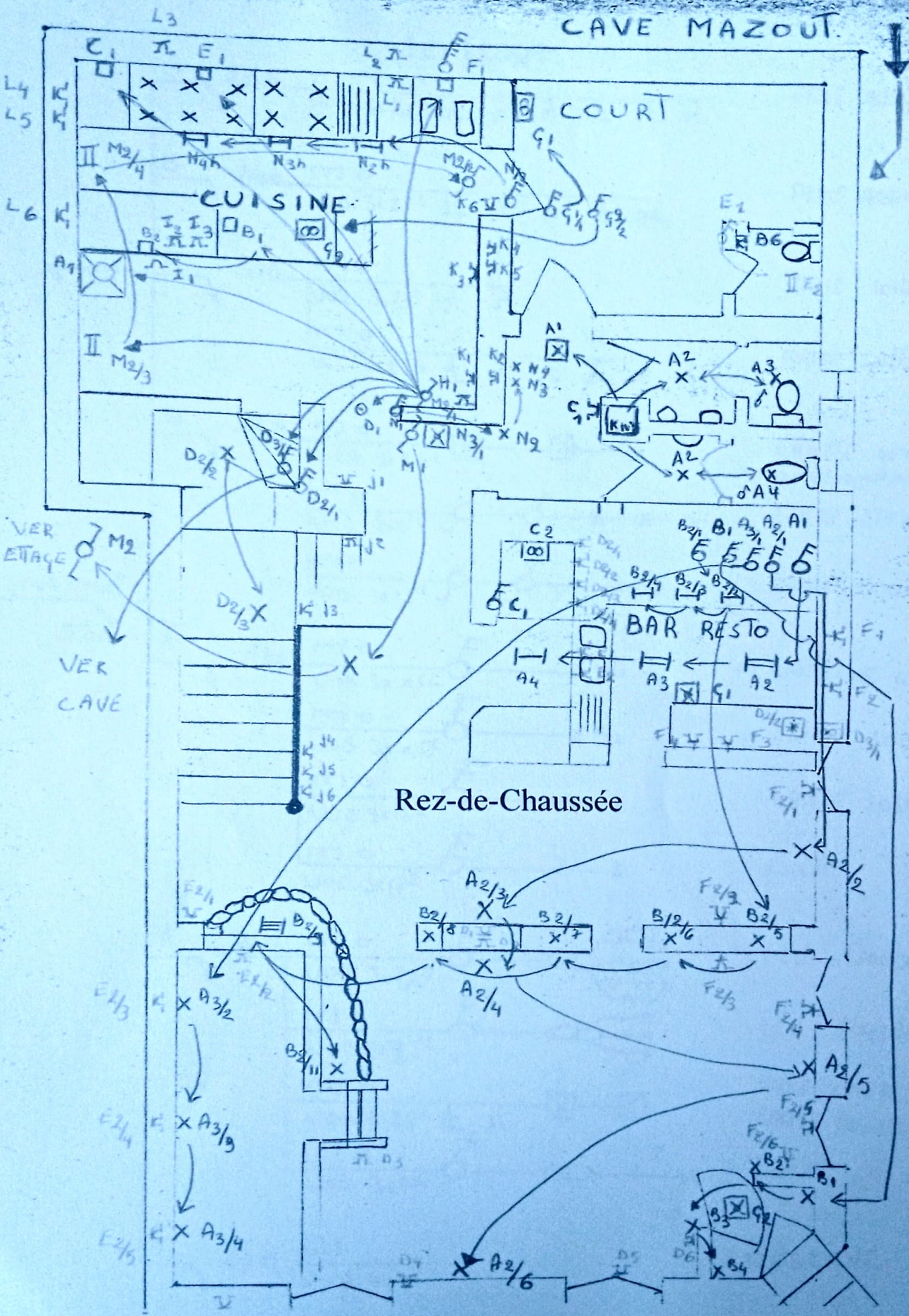

1er Etage

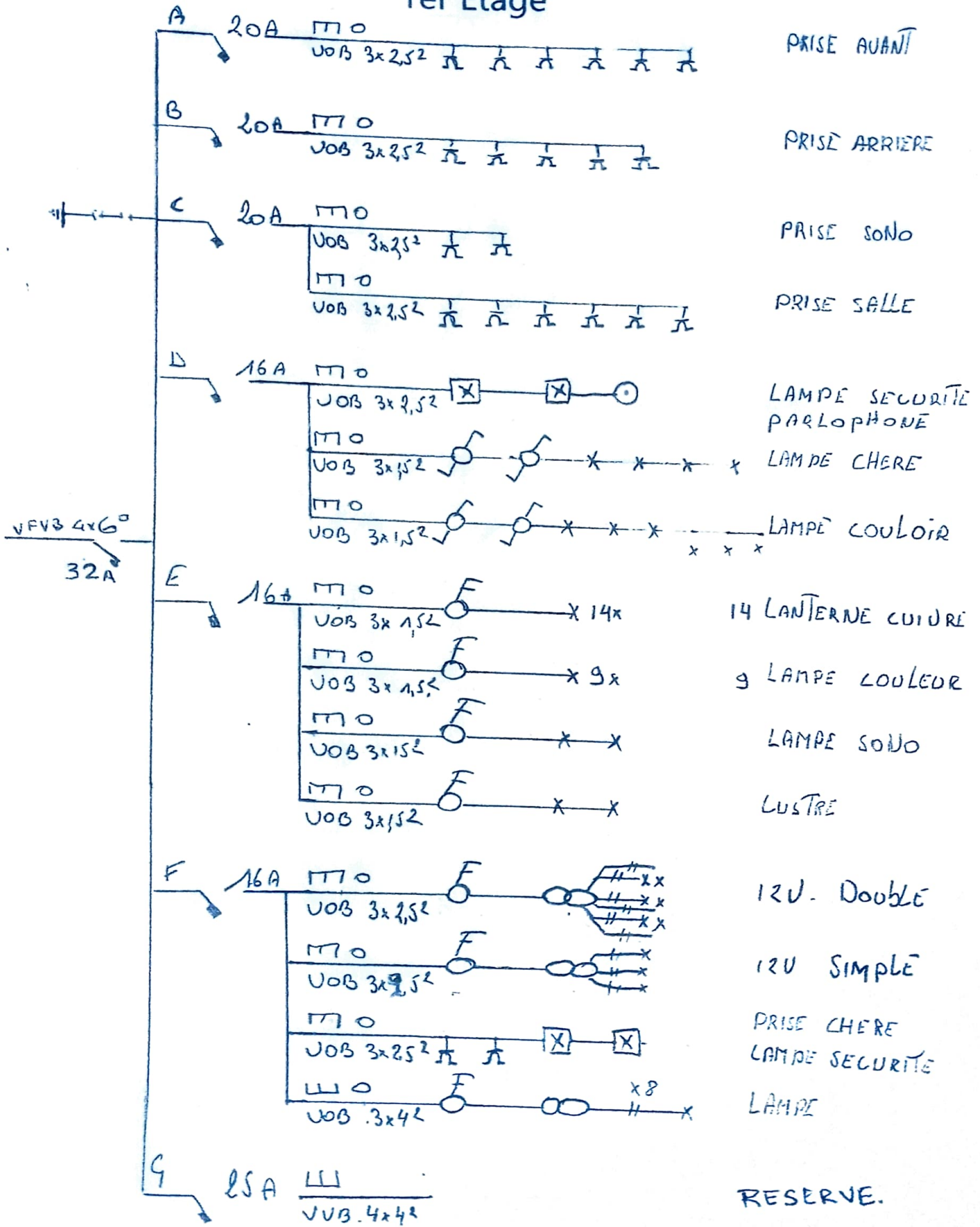

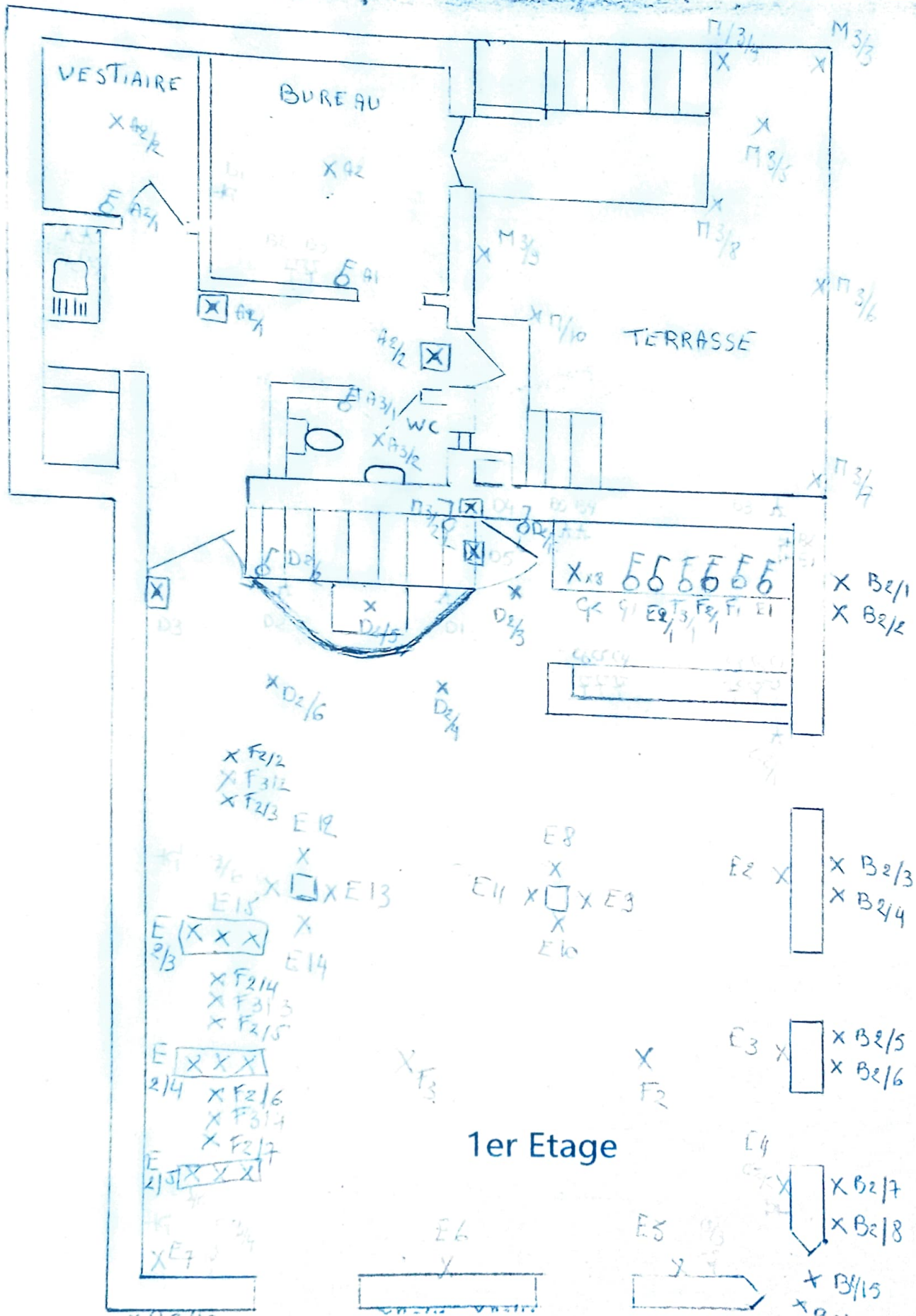

2eme Etage

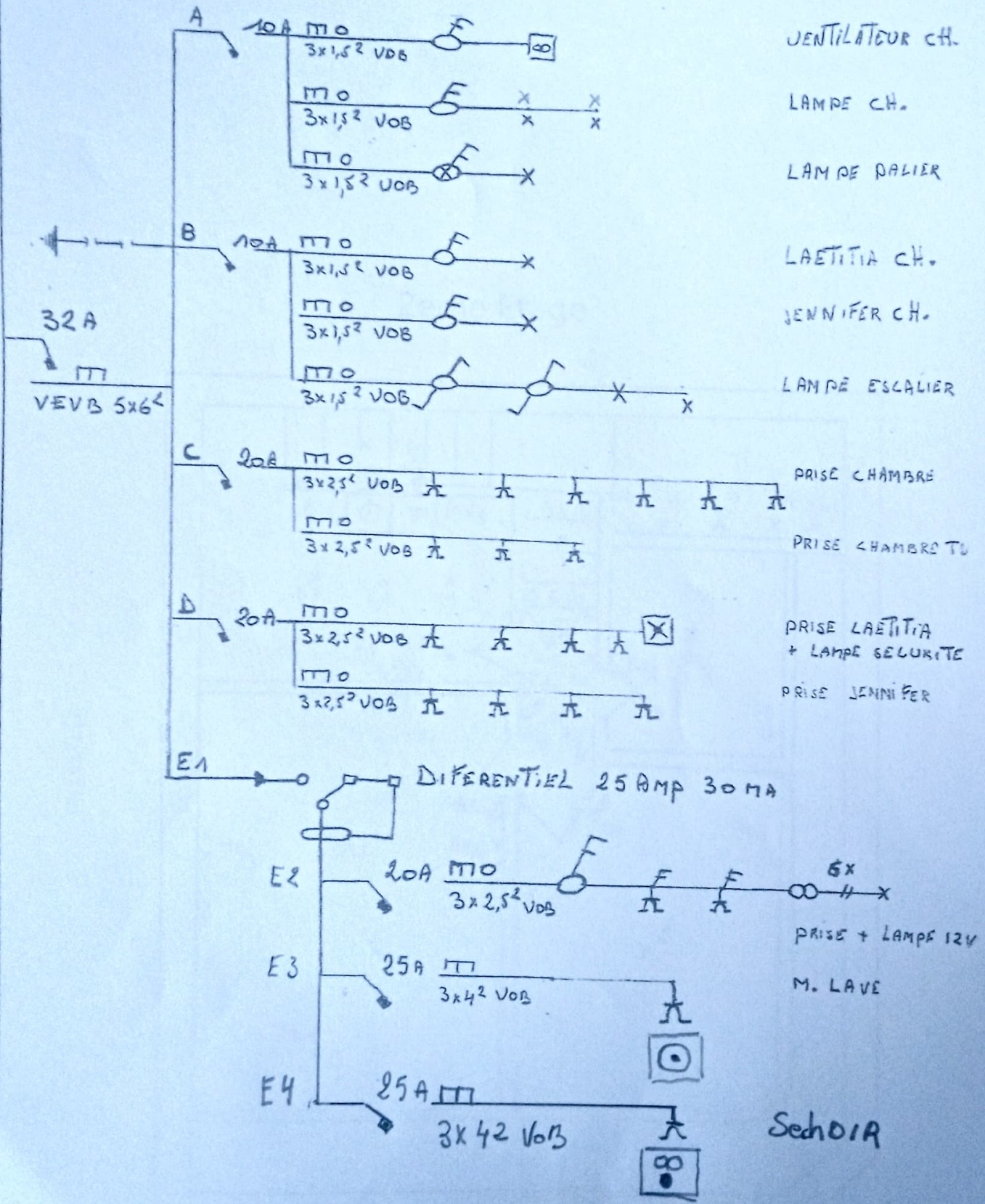

2eme Etage

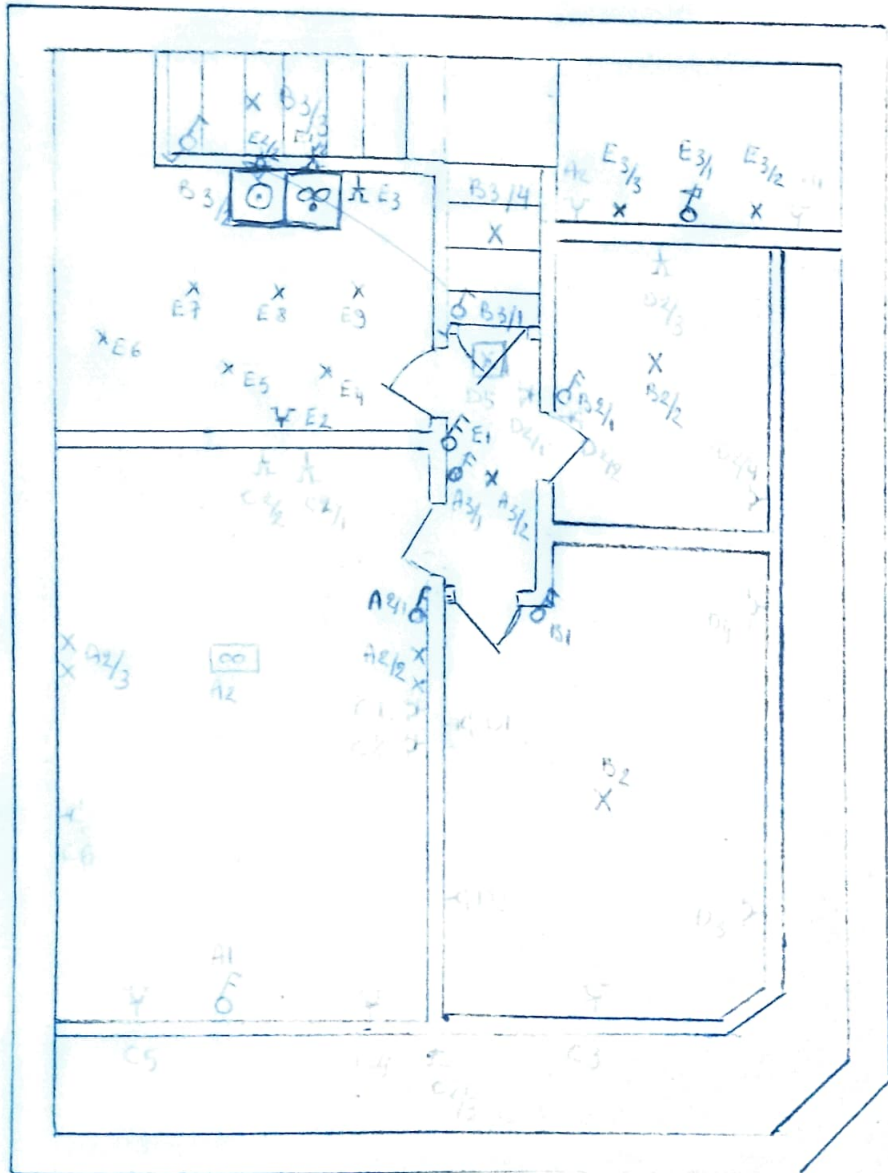

Caves

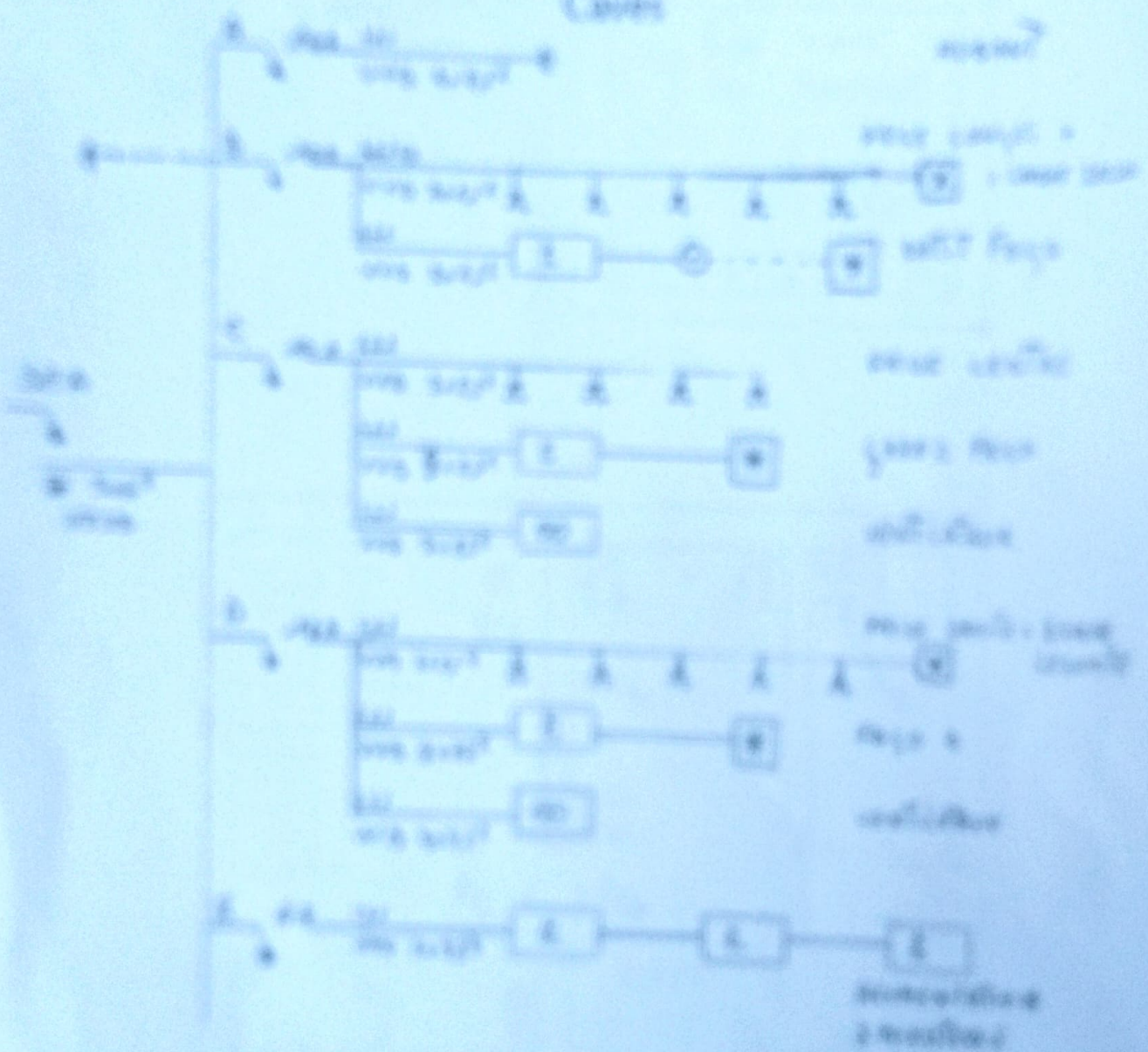

Caves

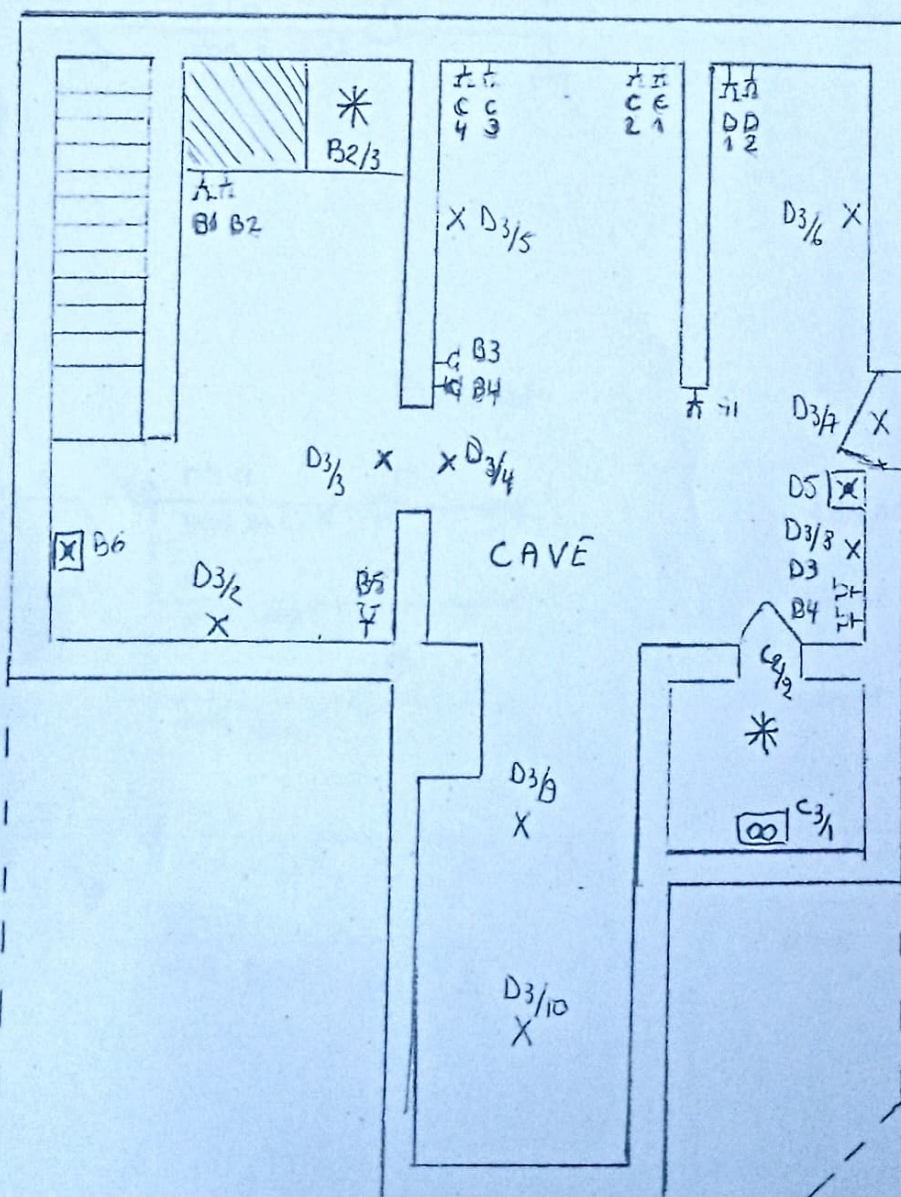
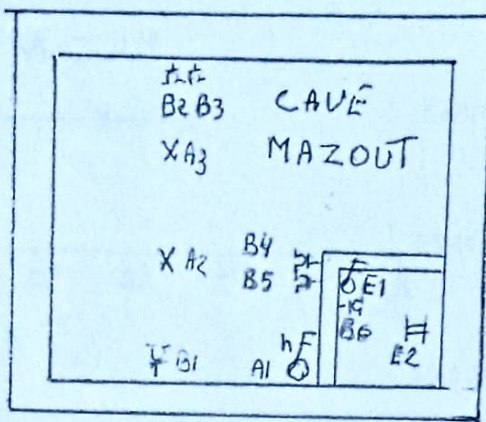

Cave Mazout

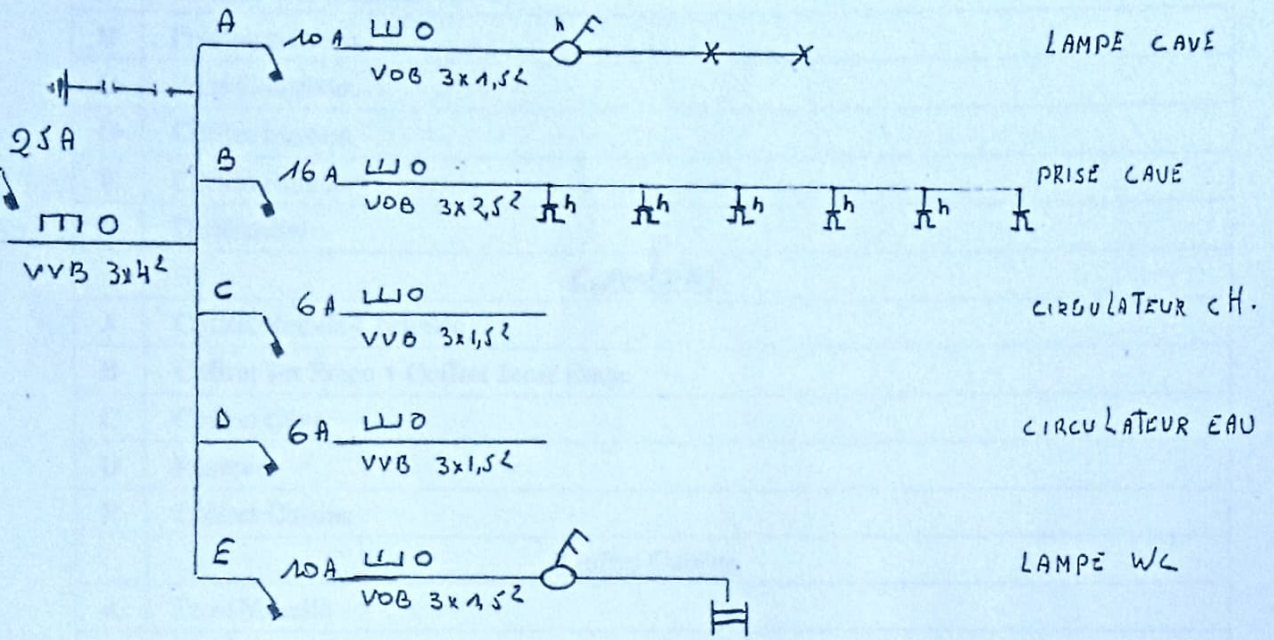

Bureau

