

20240620  
0504

ACA vzw - Eikend Controle Organisme  
Meensesteenweg 338 - 8800 Roeselare  
BTW BE 0811.407.869

Tel: 051/20 00 02 - Fax 051/20 10 02  
info@pvc.be

12/12/2020

19/10/2024

QACEG  
Sociaal Verzekering  
Sociale Nuyts

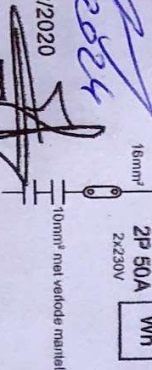

Wh  
Bilkeemail.

034 300 mA  
2P A  
2P 50A  
2P 33A 30mA  
VOB 10mm²

VOB 10mm²

Responsible dep. Beelbroekhof 127

Technical reference

Created

Document type

Approved

Document status

Rev.

Eendradsschema

Title, supplementary title

Date of issue

Scale

Lang.

Sheet

Kring A tot M

1/1

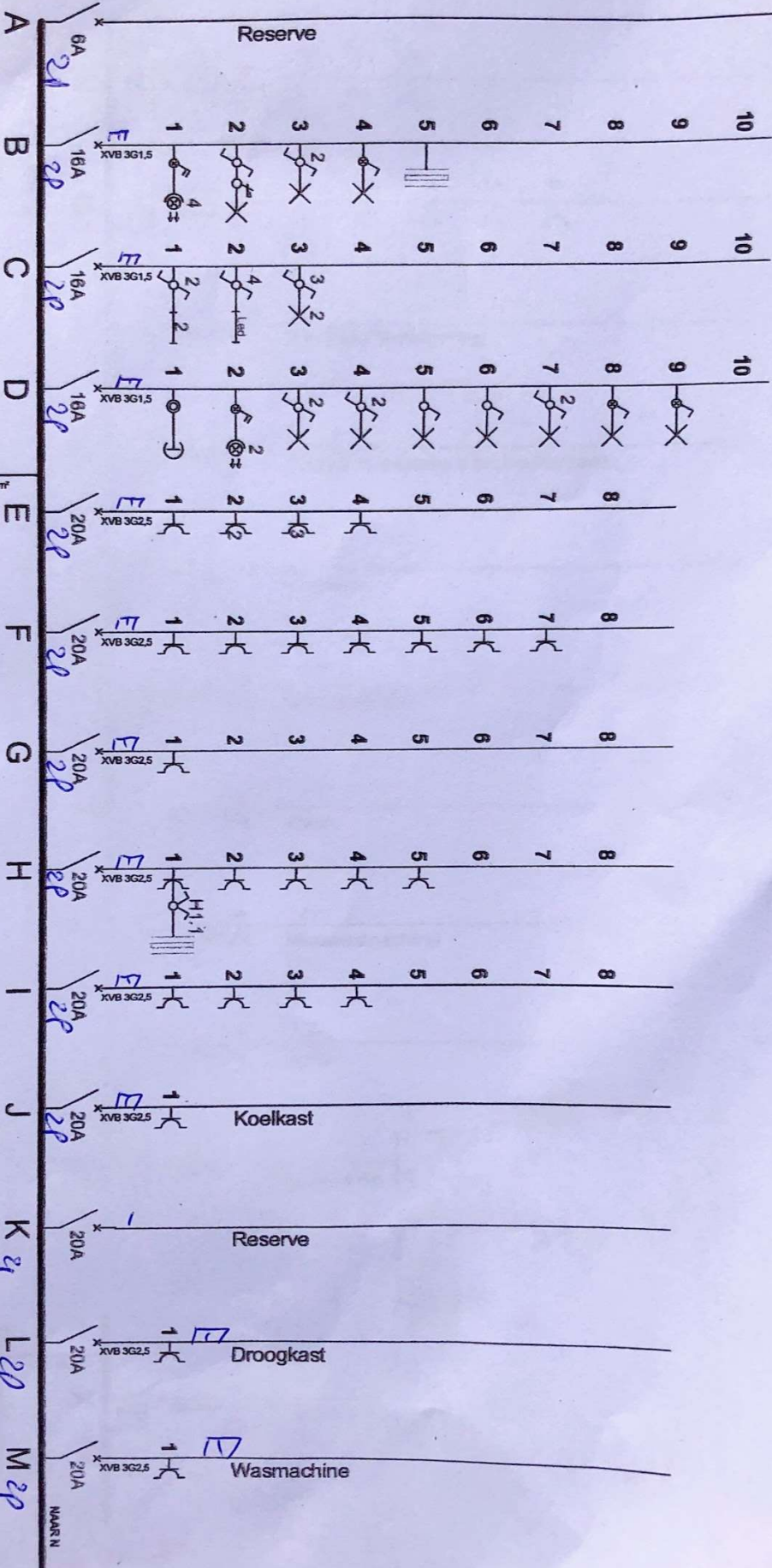

NAAR 300mA

NAAR N



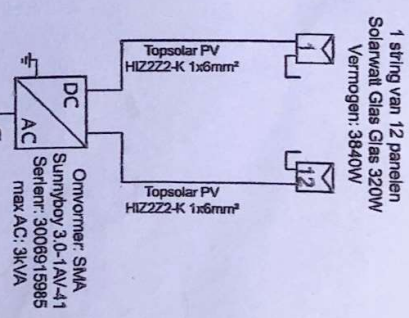
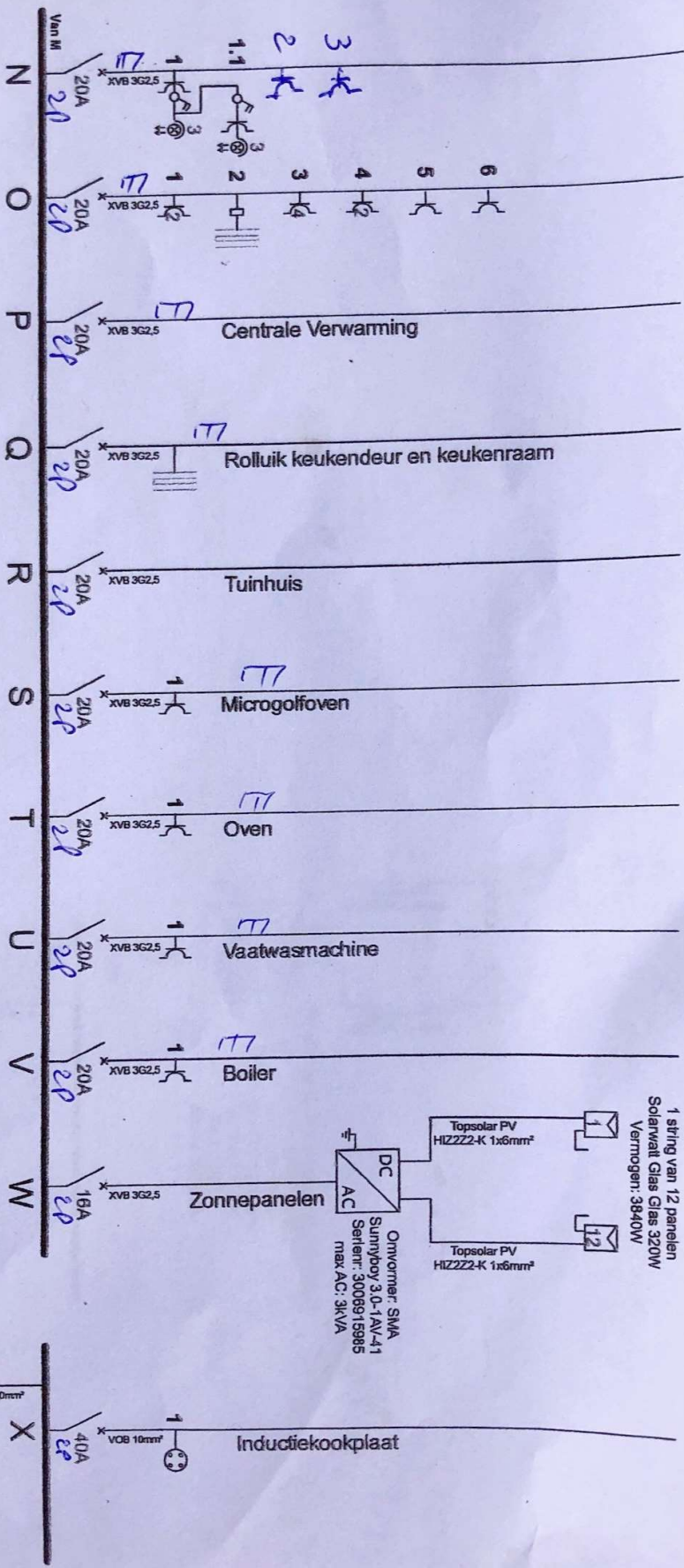

ACA VZW - Erkend Controle Organisme  
 Moensestechnweg 599 - 9999 Fosselste  
 BTW BE 0211 407 869  
 Tel. 051/20 00 02 - Fax 051/20 10 02  
 info@aca.be - www.aca.be

*[Handwritten signature]*

Responsible dep.	Technical reference	Created	Approved
Beelbroekhof 127			

Document type	Document status	Rev.
Eendradschema		

Title, supplementary title	Date of issue	Lang.	Sheet
Kring N tot X			1/1



12/1/2020

1 string van 12 panelen  
 PV panelen  
 Solarwatt Vision 60M style (black edition) 320W  
 Afmetingen: 1700-1000-40  
 Vermogen: 3840W

Spanning Vmp 33,6V  
 Stroom Imp 9,52A  
 Nullesspanning Voc 40,2V  
 Kortsluitstroom Isc 10,20A

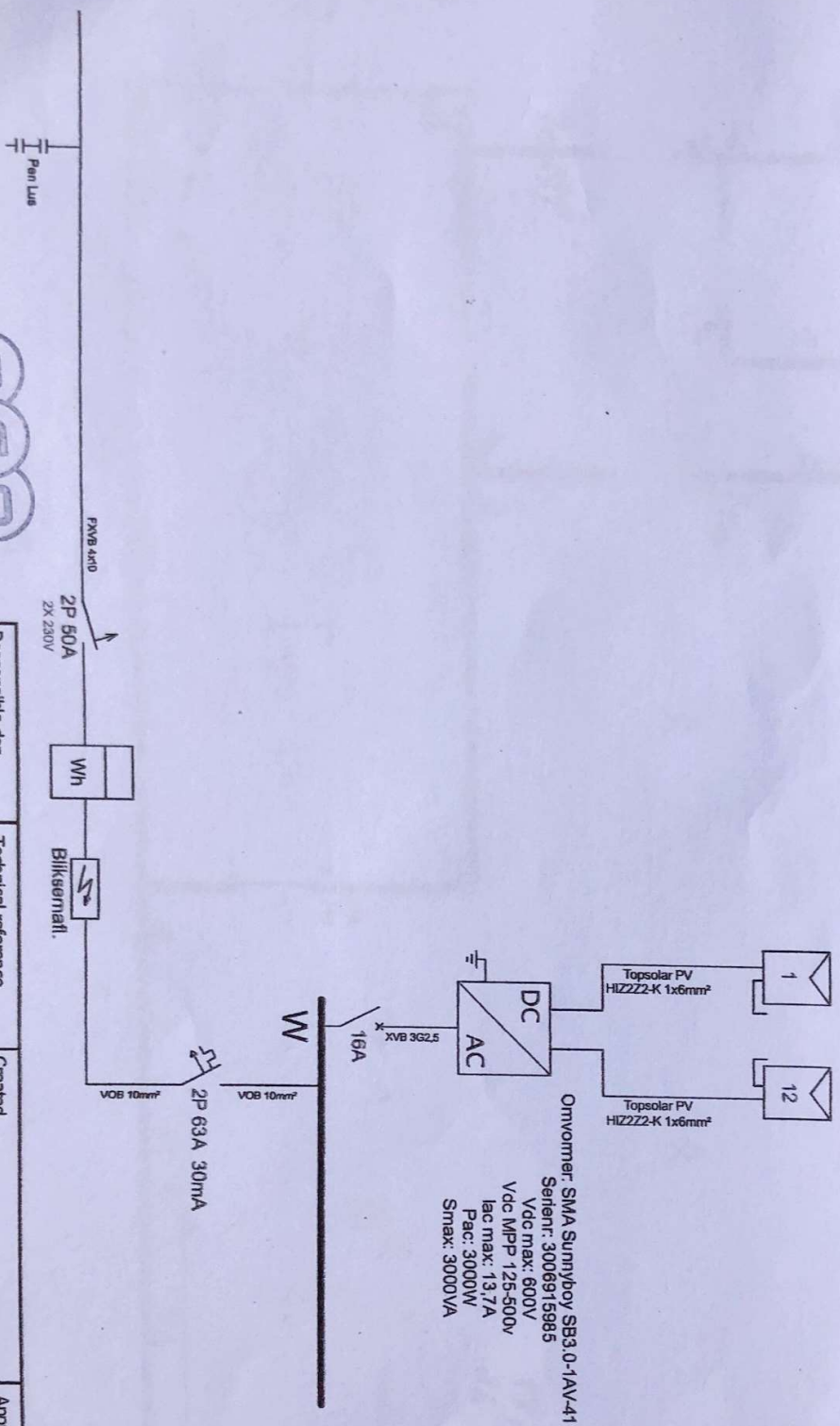

Omvormer: SMA Sunnyboy SB3.0-11A-V-41  
 Serienr: 3006915985  
 Vdc max: 600V  
 Vdc MPP 125-500V  
 Iac max: 13,7A  
 Pac: 3000W  
 Smax: 3000VA

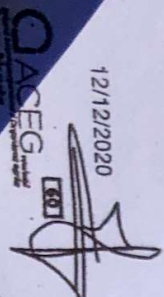

12/12/2020

ACA VZW - Erkend Controle Organisatie  
 Meensesteenweg 3-8 - 9200 Roeselare  
 BTW BE 0841407869  
 Tel. 051 511 00 02 Fax 051 20 10 02  
 info@aca.vzw  
 www.aca.vzw/be



19/06/2024

Responsible dep. <b>Beelbroekhof 127</b>	Technical reference	Created	Approved	Rev.
Document type <b>Eendraadschema Zonnepanelen</b>		Document status	Scale	
Title, supplementary title		Date of issue	Lang.	Sheet
				<b>1/1</b>



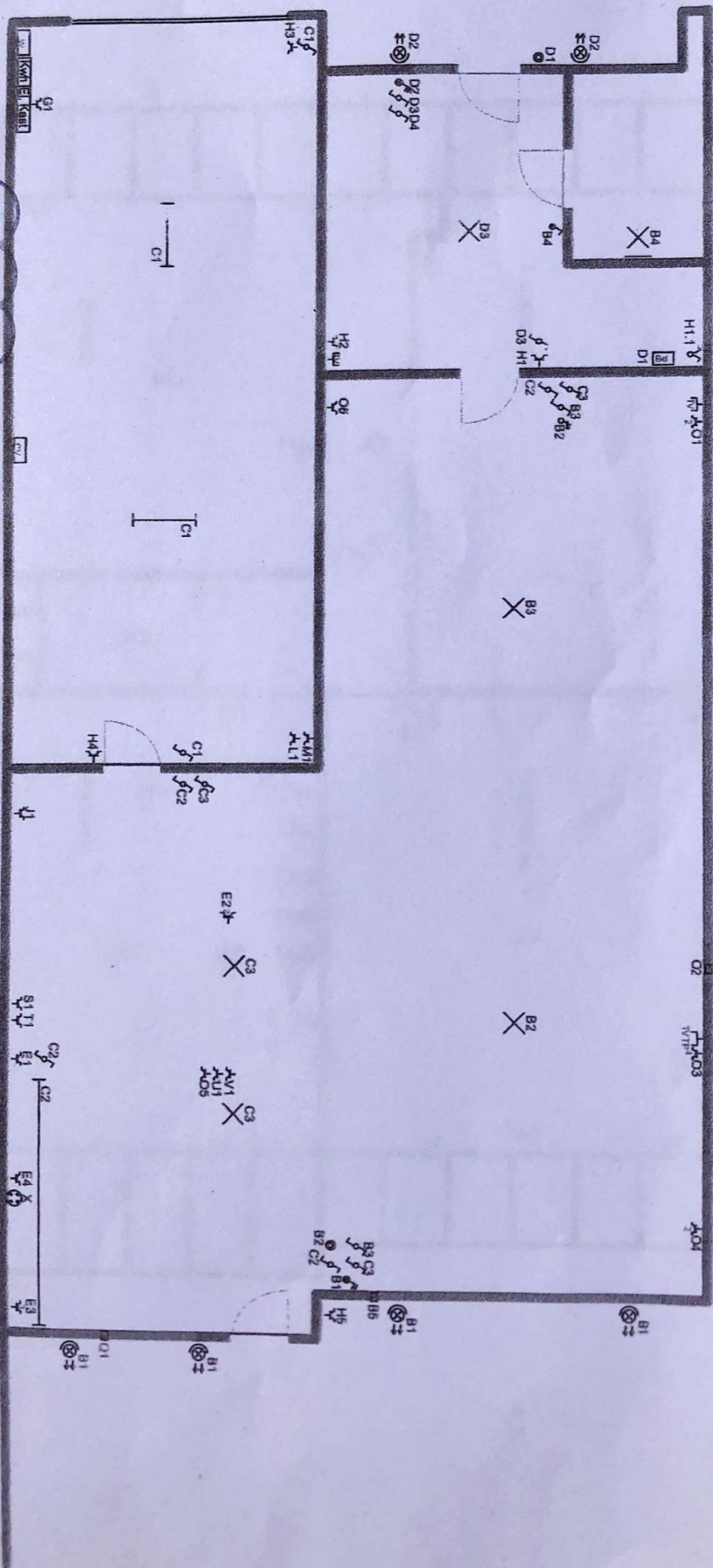

ACA VZW - Erkend Controle Organisme  
 Meensesteenweg 338 - 8800 Rosseleare  
 BTW BE 0811.407.866  
 Tel. 067/20 00 02 FAX 057/20 40 02  
 info@aca.be



Uitvoerend voorzitter / Deputy  
 Jens Nuyts

Responsible dep. <b>Beelbroekhof 127</b>	Technical reference	Created	Approved	Document status	Rev.
<b>proficad</b>		Document type <b>Situatieschema Elektriciteit</b>	Date of issue <b>11/10/2020</b>		
		Title, supplementary title <b>Beneden</b>			

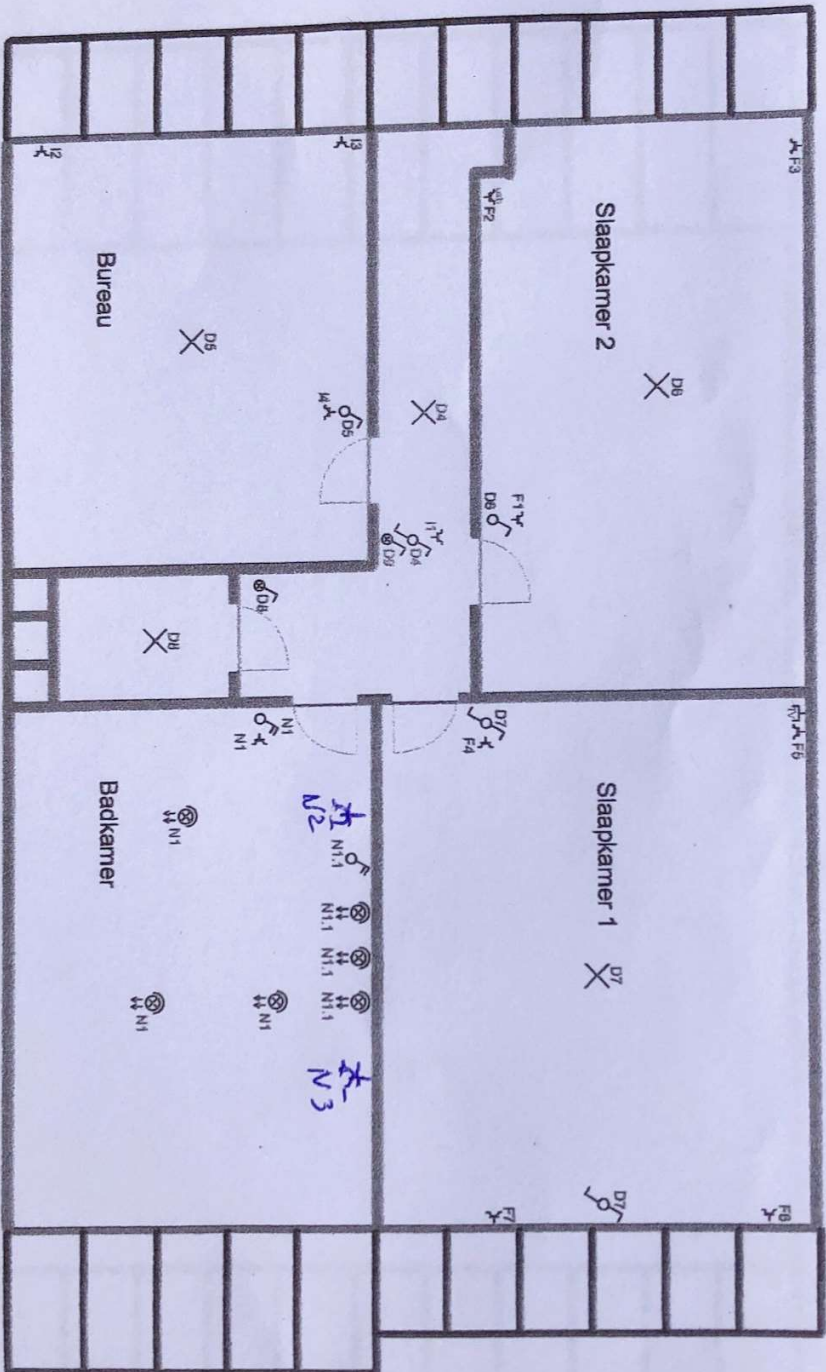

ACA VZW - Eikend Controle Organisme  
 Moensstedenweg 338 - 8800 Rooselare  
 BTW BE0811 497 869  
 Tel. 051/20 00 02 - Fax 051/20 10 02

GACEG 60  
 Leed verantwoordelijke / Organisme opzet  
 Jens Nuyts

Responsible dep. <b>Beelbroekhof 127</b>	Technical reference	Created	Approved
<h1>proficad</h1>		Document type <b>Situatieschema Elektriciteit</b>	Document status
		Title, supplementary title <b>Boven</b>	Rev.
		Date of issue <b>11/10/2020</b>	Scale
		Lang.	Sheet <b>1/1</b>



